

10%
made in Italy

Medical Line

DreaMed Zak

Medic experience
Esperienza medica



Multifunctional couch-bed
Poltrona-lettino multispecialistica

Lemi[®]
MADE IN ITALY

Movements / Movimentazioni

ENT VISITS • DENTAL SURGERY AND IMPLANTOLOGY
STOMATOLOGY • ORTHODONTICS • OPHTHALMOLOGY
DIAGNOSTICS • MINOR SURGERY INTERVENTIONS

4 independent electric movements: height, back rest, leg rest, trendelenburg
1 synchronized electric movement: back rest/leg rest
2 manual movements: rotation and leg rest extension
Automatic reset control to bring the couch back to the initial position

Electric height
Altezza elettrica
58-83 cm
(21"-33")

Electric Trendelenburg
Trendelenburg elettrico



30°



180°

90° rotation on both sides
Rotazione 90° da entrambi i lati

VISITE DI OTORINOLARINGOIATRIA • CHIRURGIA DENTALE E IMPLANTOLOGIA
STOMATOLOGIA • ORTODONZIA • OFTALMOLOGIA
DIAGNOSTICA • PICCOLI INTERVENTI AMBULATORIALI

DreaMed Zak · cod. 336

4 movimenti elettrici indipendenti: altezza, schiena, gambe, trendelenburg
1 movimento elettrico sincronizzato: schiena/gambe
2 movimenti manuali: rotazione ed estensione gambe
Comando di azzeramento automatico che riporta il letto nella posizione base

Synchronized back rest/leg rest movement

Movimentazione sincronizzata schiena/gambe

Electric leg rest
Gambe elettriche



90°



80°

Electric back rest
Schiena elettrica



Adjustable leg rest
Gambe estraibili



3 motors version cod. 332

3 manual movements:
rotation, leg rest inclination and extension

Versione 3 motori cod. 332

3 movimenti manuali:
rotazione, inclinazione ed estensione gambe

ENT VISITS • DENTAL SURGERY AND IMPLANTOLOGY
STOMATOLOGY • ORTHODONTICS • OPHTHALMOLOGY
DIAGNOSTICS • MINOR SURGERY INTERVENTIONS



Wide choice of upholsteries available on stock

Ampia scelta di rivestimenti disponibili a stock

The adjustable and removable headrest offers the opportunity to get next to patient's face. It is highly customizable depending on treatment.

La testa regolabile ed estraibile offre uno spazio di lavoro idoneo per poter intervenire sulla zona del viso del paziente. E' altamente personalizzabile in relazione al tipo di trattamento.

Easy-to-clean anatomic mattress without stitching

Materasso anatomico senza cuciture per una facile igienizzazione

Its complete ABS covering grants elegance and safety while protecting the inner components from liquids

Completamente chiuso con carter in ABS garantisce alla poltrona eleganza e sicurezza, proteggendo i componenti interni dai liquidi

Maximum load weight without risk 200 kg

Portata max in sicurezza 200 kg

Predisposition for medical accessories to adapt the couch to any purpose

Predisposizione accessori medicali per adattare la poltrona ad ogni utilizzo

2 adjustable small feet under the base

2 piedini regolabili alla base

4 electric actuators current continuous 24V cc

4 motori elettrici 24V cc a regolazione continua

Foot pedal control with automatic reset to zero

Pedaliera con azzeramento automatico



Technical specifications

Minimum height: 52 cm - 20"
Maximum height: 82 cm - 32"
Angle of inclination trendelenburg: 30°
Angle of inclination back rest: 80°
Angle of inclination leg rest: 90°
Mattress length: 168 cm - 66"
Mattress length (with extended leg rest):
185 cm - 73"
Mattress width: 59 cm - 23"
Rotation: 90° on both sides
Latex-free, non-toxic and non-carcinogenic
materials
Fire-resistant upholstery: UNI 9175 class 1M

Specifiche tecniche

Altezza minima: 52 cm
Altezza massima: 82 cm
Angolo inclinazione trendelenburg: 30°
Angolo inclinazione schiena: 80°
Angolo inclinazione gambe: 90°
Lunghezza materasso: 168 cm
Lunghezza materasso gambe estese:
185 cm
Larghezza materasso: 59 cm
Rotazione: 90° su entrambe i lati
Materiali privi di lattice, atossici e non
cancerogeni
Rivestimento ignifugo: UNI 9175 class 1M

Electric requirements

Voltage: 230/110V ac
Frequency: 50 Hz / 60 Hz
Absorption: 0,70 A max
Electric system conforms to CEI norms
4 actuators 24 VDC (thrust 6000 N)
Class II control box 220Vac 50Hz
Transformer 120 Va
Class I medical device (dir. 93/42/CEE)
Protection rating IP54
Low-tension foot pedal control

Packaging details

Size: 170x74x86h cm (67"x30"x34")
Volume: 1,081 m³
Gross weight: 92 kg - 203 lbs
Net weight: 76 kg - 168 lbs

Caratteristiche imballo

Dimensioni: 170x74x86h cm
Volume: 1,081 m³
Peso lordo: 92 kg
Peso netto: 76 kg

Caratteristiche elettriche

Voltaggio: 230/110V ac
Frequenza: 50 Hz
Assorbimento: 0,70 A max
Impianto elettrico a norme CEI
4 attuatori 24 VDC (spinta 6000N)
Centralina in classe II 220 Vac 50Hz
Trasformatore da 120 Va
Disp. Medico classe I (dir. 93/42/CEE)
Grado di protezione IP54
Pedaliera a bassa tensione

Warranty

Structure: 10 years
Motors and control: 2 years
Cushion: 5 years

Garanzia

Struttura: 10 anni
Motori e comandi: 2 anni
Imbottitura: 5 anni

Accessories upon request / Accessori su richiesta



cod. 108



cod. 316-317



cod. LEM-084



cod. GOP-012



cod. 354



cod. 314



cod. 318



cod. 313



cod. LEM-139



cod. 319-320



cod. LEM-151

cod. 108

roll holder/porta rotolo

cod. 316-317

seat and back rest medical guide couple
coppia guide medicali seduta e schiena

cod. LEM-084

hand set control / pulsantiera

cod. GOP-012

lamp adaptor featuring a 60 mm
diameter column
adattatore per supporto lampada
completo di colonna ø60 mm

cod. 354

metal tray with support/vassoio con supporto

cod. 314

blood-sample taking armrest
coppia braccioli da prelievo con snodo

cod. 318

jointed thigh support couple
coppia reggicosce con snodo

cod. 313

medical armrest couple
coppia braccioli medicali

cod. LEM-139

wheels/ruote

cod. 319-320

fixed and rotating clamp couple
coppia morsetti fissi girevoli

cod. LEM-151

heel support couple/coppia reggi tallone

Mattress colors / Colori materasso

P35

Bianco



B41

Grigio

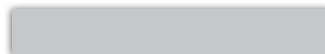

B99

Nero

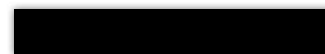

D02

Crema

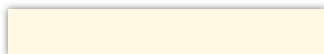

G10

Blu



H98

Viola

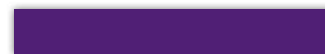

G03

Azzurro



EB1

Verde



E16

Marrone

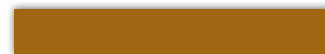

G85

Cielo

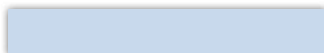

N31

Arancio



Q73

Mais



ABS covering colors/ Colori carter

336 G

Light grey
Grigio



336 B

White
Bianco



The colors above are provided only as a guide and could be subjected to a variation due to the material different from the printed paper.

I colori sopra riportati sono indicativi e possono essere soggetti a variazioni dovute al materiale diverso dalla carta stampata.

Product images are for illustrative purposes only.
The manufacturer has the right to modify pictures and descriptions
of this catalogue at any time for commercial or technical purposes.

*L'immagine ha il solo scopo illustrativo.
Il costruttore si riserva il diritto di effettuare le modifiche
alle immagini e alle descrizioni di questo catalogo
in ogni momento per esigenze di carattere
tecnico e commerciale.*

credits:

photo by Studio Pi-Tre



N° 443.090.V



Table of dimensions / *Tabella dimensionale*

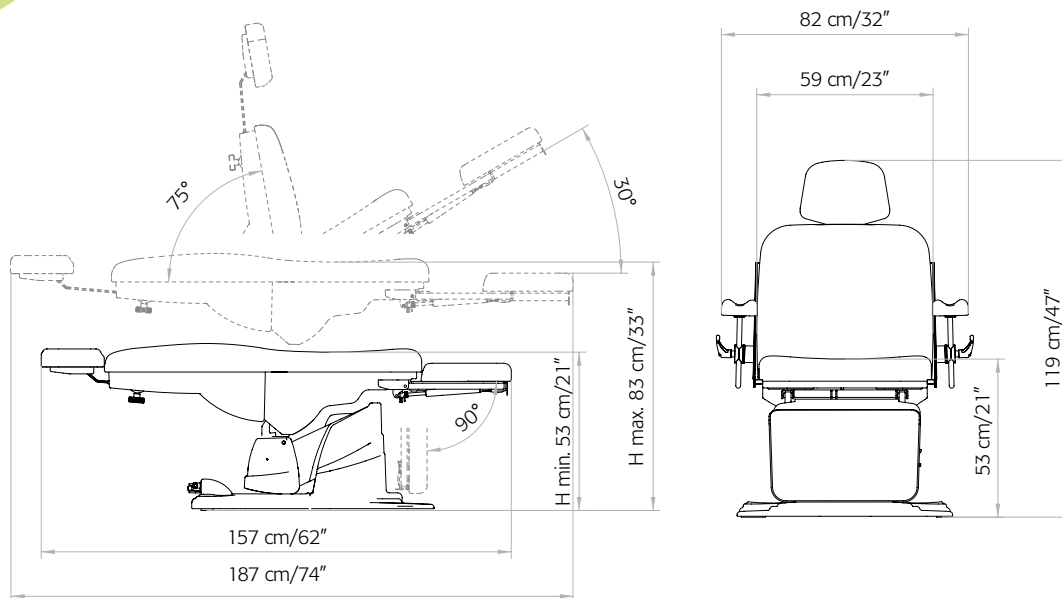

DreaMed Zak is CE conformed and is manufactured in accordance
with European Directives: 93/42/CE (class I); 2006/42/CE;
2004/108/CE; CEI EN 60204-1:2006-09; UNI EN 12100-1-2

*DreaMed Zak è a norme CE ed è fabbricato in conformità alle seguenti
Direttive Europee: 93/42/CE (classe I); 2006/42/CE; 2004/108/CE;
CEI EN 60204-1:2006-09; UNI EN 12100-1-2*



Brusaferrì & C S.r.l.

Headquarters / *Sede operativa*: via M. Maretti Soldi, 13 (ex S.P. n. 6)

26011 Casalbuttano (CR) • Italy

Tel. +39 0374 363068/69 • Fax +39 0374 363071

www.lemi.it • info@lemi.it

Lemi[®]
MADE IN ITALY